

SIP-230

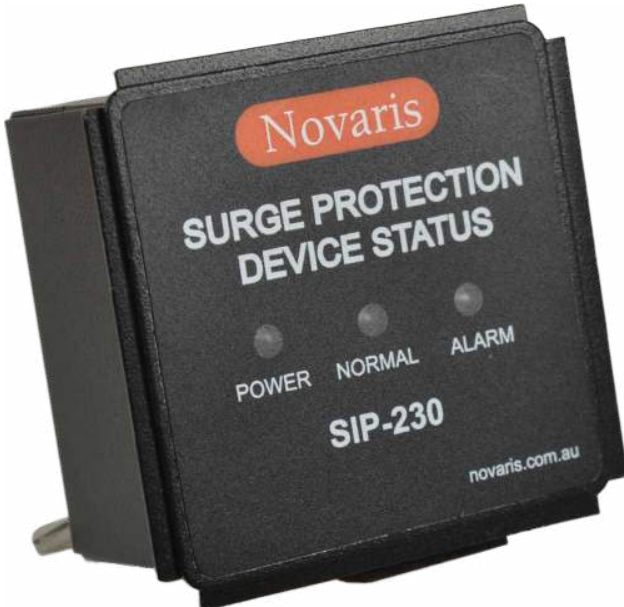

Status Indicator Panel

The Novaris surge indicator panel allows remote monitoring of any Novaris surge protectors that feature remote alarm contacts. It provides visual and audible indications as to the health of the surge protectors connected allowing rapid diagnosis and correction of any issues. It includes remote alarm contacts allowing an external indicator to be used in a control room or building management system if required. Designed to fit standard 70mm panel meter cutouts, making integration into switchboards simple and quick.

Wiring

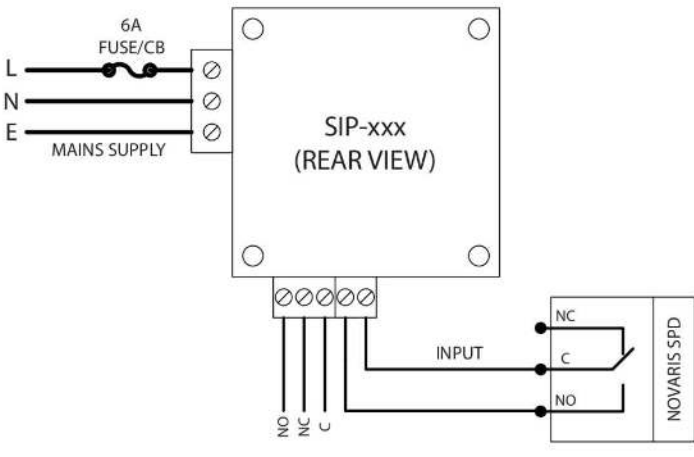

Dimensions

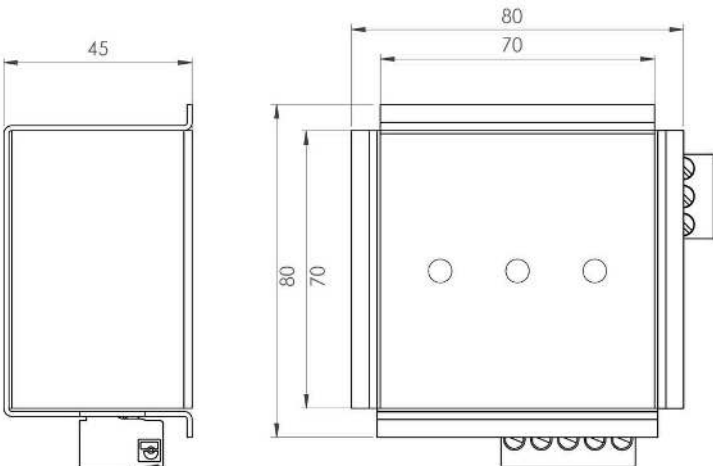

Product Datasheet











Electrical Specifications

Nominal voltage		230V
-----------------	--	------

Indication Specifications

Display		LED power and status
Alarm		SPDT contacts
Alarm isolation		4kV

Mechanical Specifications

Panel cut-out		70mm x 70mm
Minimum operating temperature		-40°C
Maximum operating temperature		70°C
Minimum operating humidity		5%
Maximum operating humidity		95%
Mounting method		Flush panel mount
Environmental rating		IP20
Enclosure material		Aluminium
Enclosure finish		Black powdercoat
Length		45mm
Width		80mm
Height		80mm

Other Specifications

Product Code		SIP-230
--------------	---	---------

Shipping Specifications

Weight		200g
--------	---	------