

SDPV-100-1000

Solar Protector

Novaris SDPV's are designed for photovoltaic system DC-side protection against the damage from surges caused by lightning or over voltages.

Replaceable pluggable elements

Pluggable design allows for easy removal and replacement.

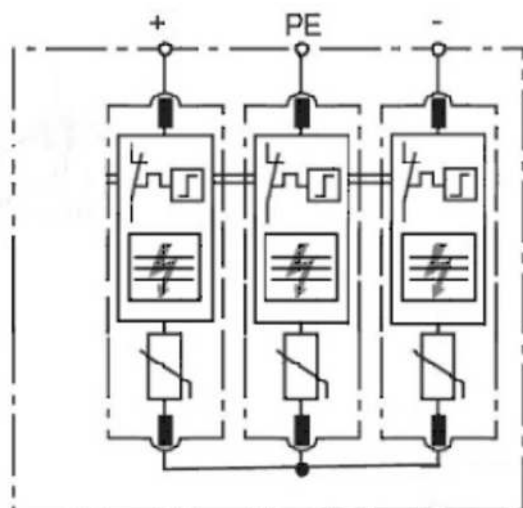
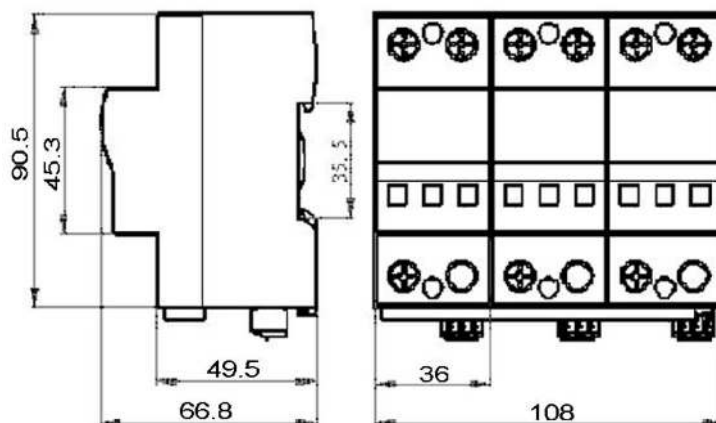
**Wiring****Dimensions**





All Dimension in mm

Standards

EN50539-11

Product Datasheet

Electrical Specifications

Connection type		Shunt
Modes of protection		(+)(-), (+)PE, (-)PE
Number of ports		1
Number of phases		2
Location		Indoor
Nominal voltage	U_0	1000VDC
Short circuit withstand level	I_{SSCR}	40kA
Maximum backup fuse		160A
Earth leakage current	I_{PE}	<1mA

Electrical (L-L) Specifications

Maximum continuous voltage DC	U_c	1060VDC
Maximum discharge current (8/20 μ s)	I_{max}	100kA
Nominal discharge current (8/20 μ s)	I_n	40kA
Lightning impulse current (10/350 μ s)	I_{imp}	12.5kA
Voltage protection level (3kA 8/20 μ s)	U_p	<4500V
Response time	t_A	<25ns













Electrical (L-PE) Specifications

Maximum discharge current (8/20 μ s)	I_{max}	100kA
Lightning impulse current (10/350 μ s)	I_{imp}	40kA
Nominal discharge current (8/20 μ s)	I_n	12kA
Voltage protection level (1kV/ μ s)	U_p	<4500V
Response time	t_A	<25ns

Indication Specifications

Display  Status indicator

Mechanical Specifications

Minimum operating temperature		-40°C
Maximum operating temperature		80°C
Minimum operating humidity		5%
Maximum operating humidity		95%
Mounting method		TS35 DIN Rail
Environmental rating		IP20
Enclosure material		Thermoplastic
Terminal capacity - power		35mm ²
Terminal screw torque - power		2Nm
Length		91mm
Width		108mm
Height		66mm

Other Specifications

Product Code  SDPV-100-1000

Shipping Specifications

Weight		500g
Customs tariff		85354010