

IS-SLT3-7V5-M20

**IS-SLT Intrinsically Safe**

The intrinsically safe and flameproof IS-SLT range provides surge protection for most twisted pair signal cables associated with intrinsically safe field devices.

IEC Ex & ATEX Approved

Novaris 'IS-SLT' products are certified intrinsically safe and flameproof according to IEC Ex and ATEX and so may be installed in Ex d rated instruments without loss of integrity.

Multistage Design

The multistage design provides a high energy gas discharge tube (GDT) as primary protection for common mode disturbances, commonly associated with lightning strikes and power system earth faults and a secondary metal-oxide varistor clamping stage across the signal lines. This combination provides very robust surge protection with high transient suppression and low let-through voltages. In addition protection is provided for cable screens which may be open circuit at the instrument.

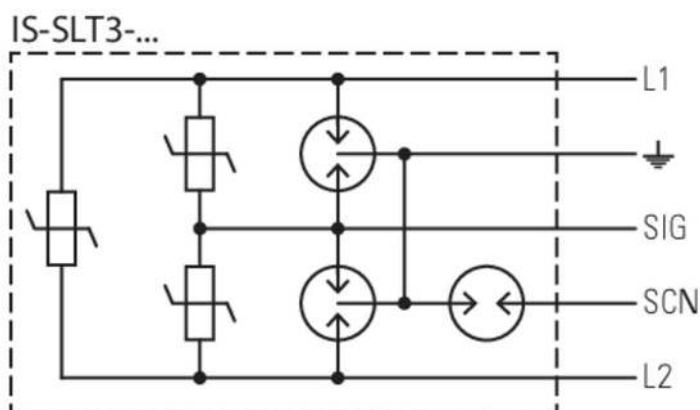
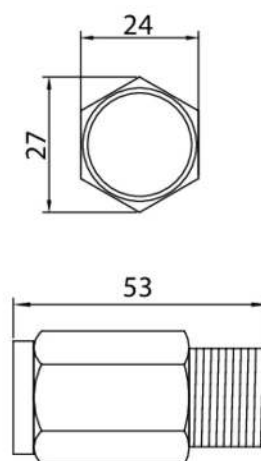
Wiring**Dimensions**



M20 x 1.5 Thread Size

Standards

Directive 94/9/EC	Equipment and protective systems intended for use in potentially explosive atmospheres
IEC 60079-0	Explosive atmospheres - Part 0: Equipment - General requirements
IEC 60079-1	Explosive atmospheres - Part 1: Equipment protection by flameproof enclosures 'd'
IEC 60079-11	Explosive atmospheres - Part 11: Equipment protection by intrinsic safety 'i'
IEC 61643-21	SPD connected to telecommunications and signalling networks - Cat C2, D1
AS/NZS 1768	Signalling/Telecommunications surge protection
UL 1449 & UL 497B	Protectors for data communications and fire-alarm circuits
ITU-T K.44	Resistibility tests for telecommunication equipment exposed to overvoltages and overcurrents

Product Datasheet

Electrical Specifications

Connection type		Shunt
Number of lines		1 pair + center
Modes of protection		Transverse & Common
Maximum continuous voltage (DC)	U_c	7V
Maximum continuous voltage (AC)	U_c	5V
Maximum discharge current (8/20 μ s)	I_{max}	5kA
Maximum common mode discharge current (8/20 μ s)		10kA
Impulse durability C2 10x8/20 μ s		2kA
Impulse durability D1 2x10/350 μ s		0.5kA
AC durability 5x1s		1Arms
Overstressed fault mode		Mode 1
Response time	t_A	<5ns
3 dB Frequency @ 150 Ω		100kHz











Electrical (L-L) Specifications

Voltage protection level @ 1 kV/ μ s	U_p	45V
Voltage protection level @ 100 V/ s		25V
Capacitance	-+-	20nF

Electrical (L-PE) Specifications

Voltage protection level @ 1 kV/ μ s	U_p	350V
Voltage protection level @ 100 V/ s		230V
Capacitance	-+-	<1pF

Mechanical Specifications

Minimum operating temperature		-20°C
Maximum operating temperature		40°C
Minimum operating humidity		5%
Maximum operating humidity		95%
Mounting method		M20
Environmental rating		IP67
Enclosure material		Stainless steel
Terminal type		Flying lead
Earthing		90V isolation
Length		53mm
Width		24mm
Height		27mm

Other Specifications

Product Code  IS-SLT3-7V5-M20

Shipping Specifications

Weight		145g
Customs tariff		85363000, 85363010